

MODEL: 93802PN
PACKING DIAGRAM

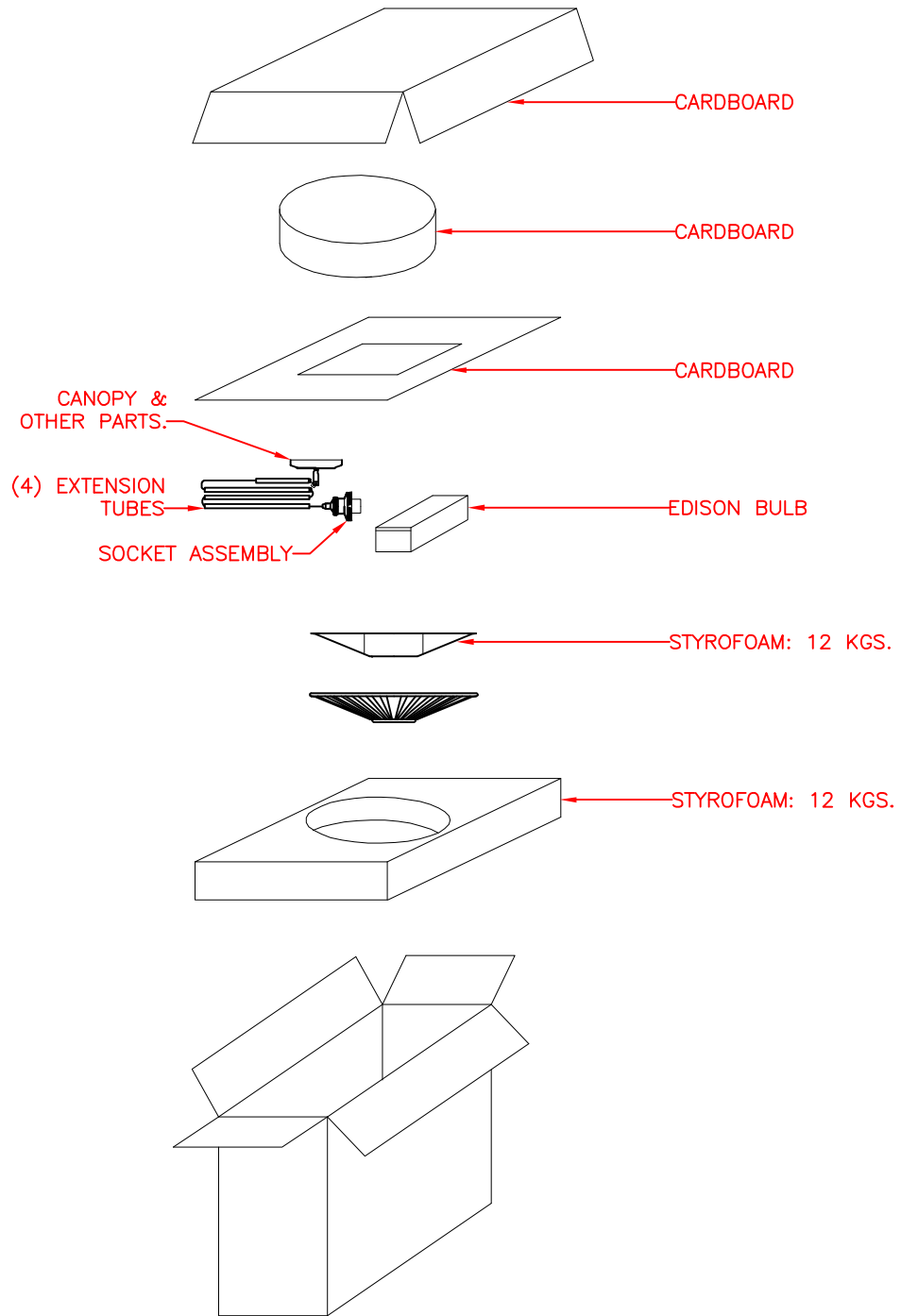

MODEL: 93802PN

ASSEMBLY INSTRUCTIONS

READ AND SAVE THESE INSTRUCTIONS

READ INSTRUCTIONS ALL THE WAY THROUGH PRIOR TO ASSEMBLY.

THIS FIXTURE SHOULD TAKE APPROXIMATELY 10 MINUTES TO ASSEMBLE.

MAKE SURE ALL PARTS ARE FIRMLY TIGHTENED.

TOOLS: YOU WILL NEED THE FOLLOWING TOOLS OR EQUIPMENT: LADDER, SCREWDRIVER, ADJUSTABLE WRENCH, WIRE CUTTERS.

UNPACK THE FIXTURE

YOU SHOULD HAVE RECEIVED THE FOLLOWING: CANOPY WITH SWIVEL, (3) 12" AND (1) 6" EXTENSION TUBES, SOCKET ASSEMBLY, GLASS SHADE, SOCKET RING AND BULB. TO PROTECT THE FINISH, PLACE ALL PARTS ON A SOFT SURFACE.

MOUNTING HARDWARE PACKAGE:

CROSSBAR, (2) 8-32 x 1-1/4" SCREWS, (2) MOUNTING SCREWS, (3) WIRE CONNECTORS, GREEN GROUND SCREW.

FIXTURE ASSEMBLY

1. REMOVE CROSSBAR FROM TOP OF THE CANOPY BY UNSCREWING (2) MOUNTING SCREWS.
2. FEED WIRE UP THROUGH TUBING AND WORKING UPWARDS TOWARD CANOPY AS SHOWN.
3. SCREW EXTENSION TUBE TO TOP OF SOCKET ASSEMBLY. (USE ANY SINGLE LENGTH OF EXTENSION TUBE OR CONNECT TUBE SECTIONS TOGETHER TO OBTAIN DESIRED LENGTH, REMOVE NIPPLE FROM EXTENSION TUBE IF NEEDED.)
4. LOOSEN THE SET SCREW AND SCREW EXTENSION TUBE TO SWIVEL ON CANOPY, AND THEN TIGHTEN THE SET SCREW.

****STOP** COMPLETE INSTALLATION INSTRUCTIONS ON NEXT PAGE BEFORE PROCEEDING.**

FINAL ASSEMBLY

1. RAISE A GLASS SHADE OVER THE SOCKET AND SECURE WITH A SOCKET RING.
2. PRIOR TO INSTALLING THE BULB, PLEASE INSPECT SOCKET FOR SILICA PACKET. IF PACKET IS PRESENT, REMOVE AND THROW AWAY. DO NOT EXPOSE TO CHILDREN AND PETS.
3. INSTALL A 120V, 60HZ, 60 WATT MAX. MEDIUM BASE EDISON BULB (INCLUDED) INTO THE SOCKET.
4. RESTORE POWER. YOUR FIXTURE IS NOW READY FOR USE.

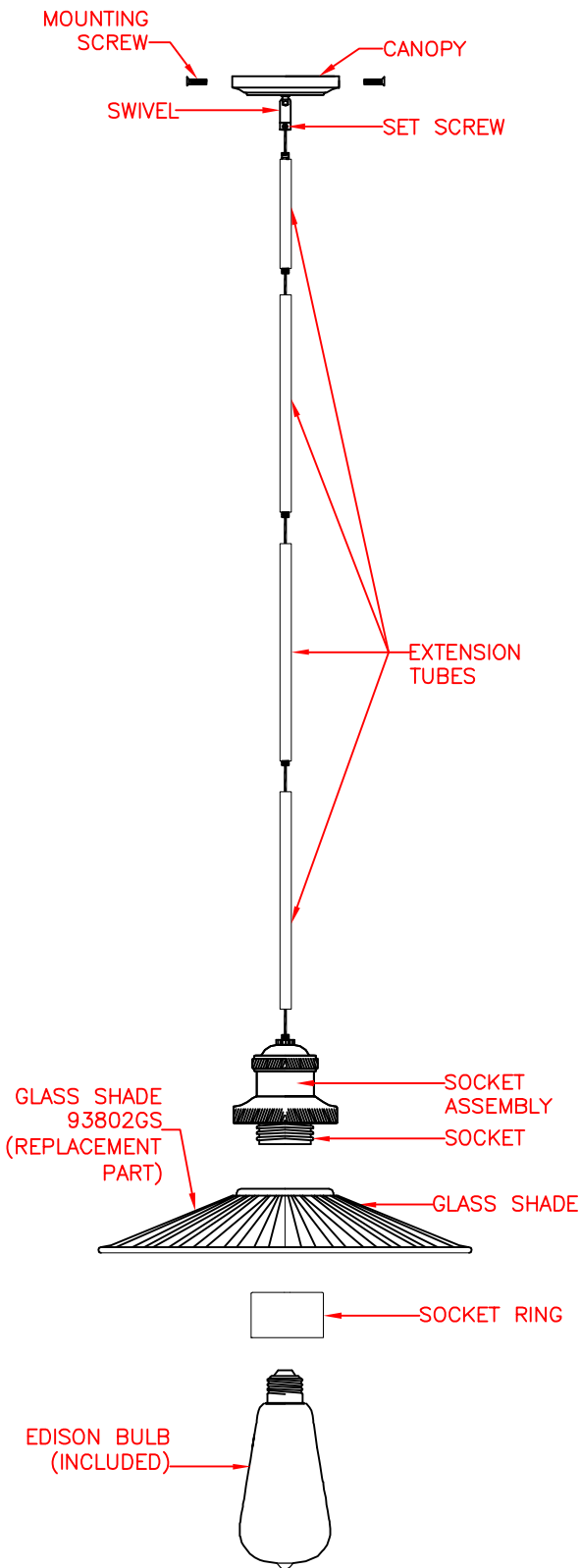

AVAILABLE PART IS:
93802GS (GLASS SHADE)



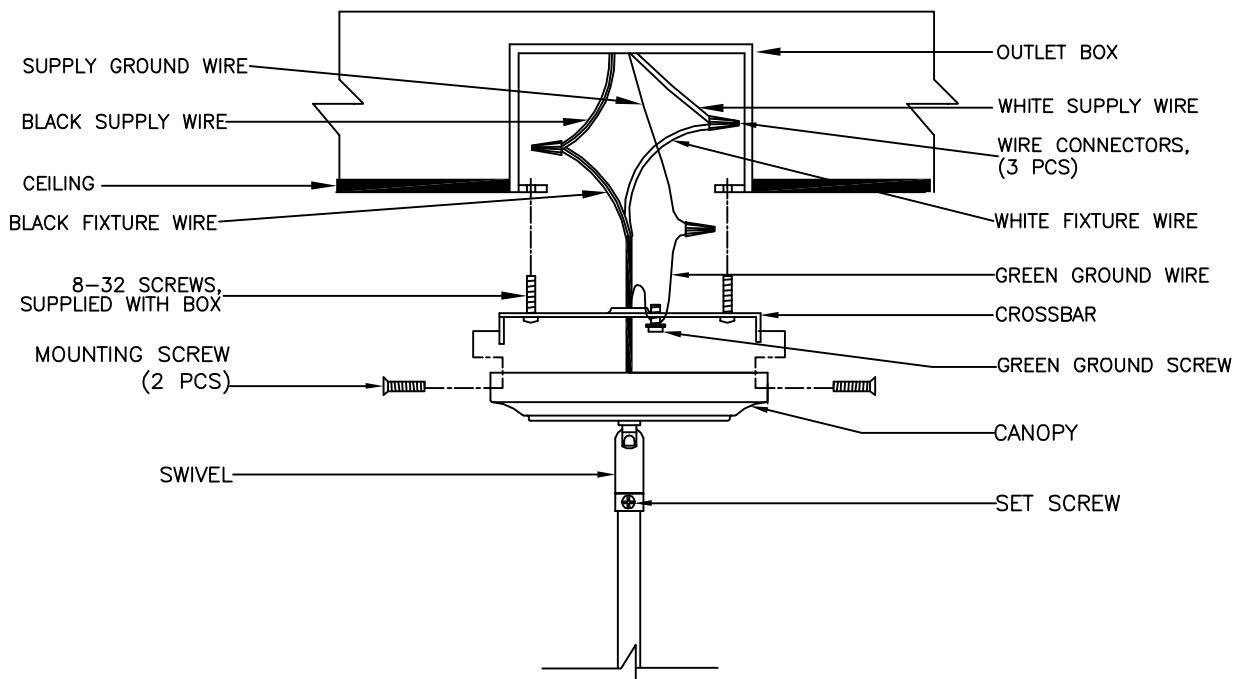

INSTALLATION INSTRUCTIONS

READ AND SAVE THESE INSTRUCTIONS

CAUTION: TO AVOID POSSIBLE ELECTRIC SHOCK, MAKE SURE THE ELECTRICITY IS SHUT OFF AT THE MAIN PANEL. IF YOU ARE REPLACING AN EXISTING FIXTURE, FIRSTLY, TURN THE FIXTURE OFF. NEXT, TURN THE WALL SWITCH OFF. FINALLY, GO TO THE MAIN FUSE OR BREAKER BOX IN YOUR HOME. TURN THE FUSE OR BREAKER TO THE OFF POSITION. SOME TYPES OF FUSES MUST BE UNSCREWED TO SHUT OFF THE POWER.

* ALL WIRING MUST BE DONE IN ACCORDANCE WITH NATIONAL AND LOCAL ELECTRIC CODES.

** IF YOU ARE NOT FAMILIAR WITH WIRING, YOU SHOULD USE A QUALIFIED ELECTRICIAN.

*** THIS FIXTURE IS INTENDED TO BE MOUNTED TO A UL LISTED OUTLET BOX CAPABLE OF SUPPORTING THE FIXTURE.

COMPLETE FIXTURE ASSEMBLY INSTRUCTIONS FIRST (SEE PREVIOUS).

1. ATTACH THE CROSSBAR TO THE CEILING OUTLET BOX USING THE TWO SCREWS PROVIDED WITH THE OUTLET BOX. (NOTE: IF THE SCREWS WITH THE OUTLET BOX ARE TOO SHORT, USE THE (2) 8-32 x 1-1/4" SCREWS PROVIDED IN THE MOUNTING HARDWARE PACKAGE).

2. CONNECT THE WHITE FIXTURE WIRES TO THE WHITE SUPPLY WIRE IN THE OUTLET BOX USING THE TWIST-ON WIRE CONNECTORS PROVIDED. CONNECT THE BLACK FIXTURE WIRES TO THE BLACK SUPPLY WIRE IN THE SAME MANNER. INSTALL THE GREEN GROUND WIRE UNDER THE GREEN GROUND SCREW ON THE CROSSBAR THEN CONNECT THE GREEN GROUND WIRE TO THE SUPPLY GROUND WIRE IN THE OUTLET BOX USING THE TWIST-ON WIRE CONNECTOR PROVIDED.

3. TUCK THE WIRES CAREFULLY INSIDE THE OUTLET BOX. SPREAD THE ELECTRICAL SPLICES SO THAT THE BLACK WIRES ARE ON ONE SIDE OF THE OUTLET BOX AND THE WHITE WIRES ARE ON THE OTHER SIDE.

4. RAISE THE CANOPY TO THE CEILING AND SECURE IN PLACE WITH (2) MOUNTING SCREWS.

5. SEE PREVIOUS PAGE FOR FINAL ASSEMBLY INSTRUCTIONS.

